

Layout时，二极管(D4、D5、D6)阴极要与
6脚芯片EG3011的接地脚(4脚)就近连接接地

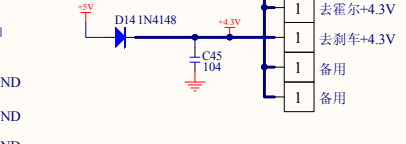
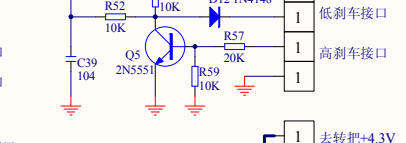
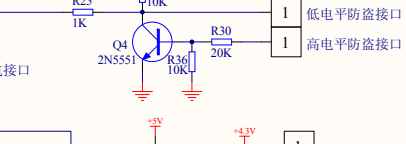
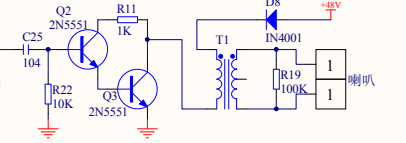
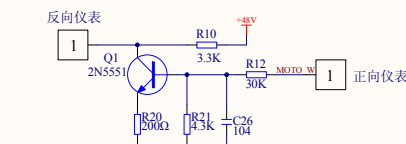
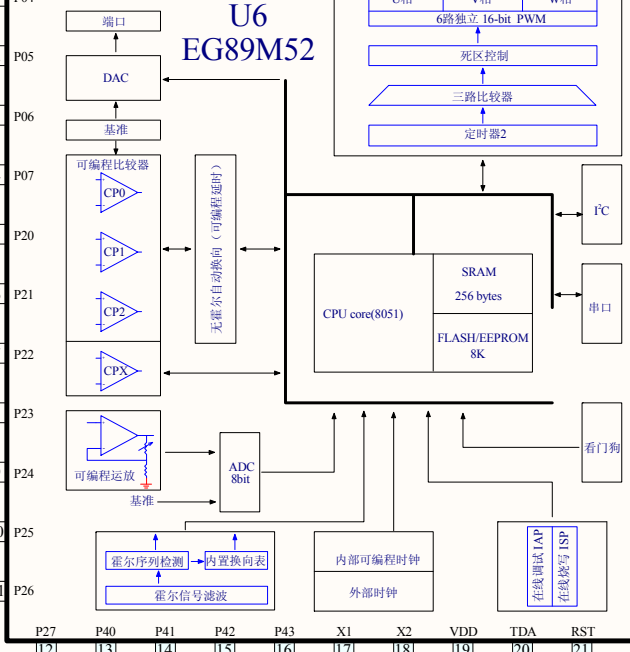
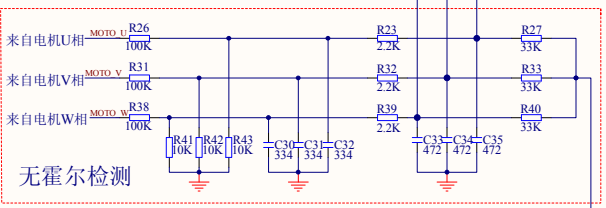

基于EG89M52、EG3011、EG1181电动车无霍尔控制器
屹微电子
www.EGmicro.com

烧写接口